

REV.	ECN NO.	DESCRIPTION	DESIGN	DATE
A		INITIAL	Kai	2018.03.29

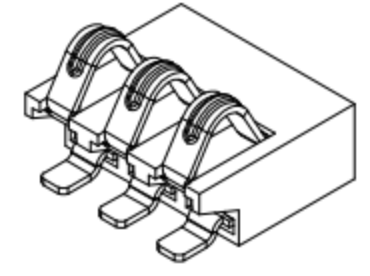

Pin(N)	DIMA	DIMB	DIMC
3Pin	4.80	3.20	0
4Pin	6.40	4.80	0
5Pin	8.00	6.40	3.20
6Pin	9.60	8.00	4.80
7Pin	11.20	9.60	6.40
8Pin	12.80	11.20	8.00
9Pin	14.40	12.80	9.60
10Pin	16.00	14.40	11.20

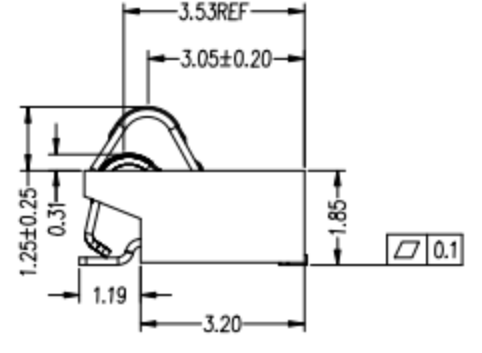
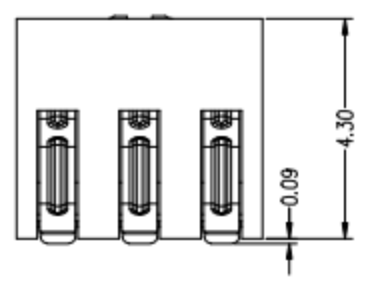
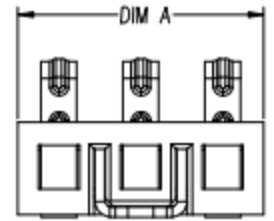
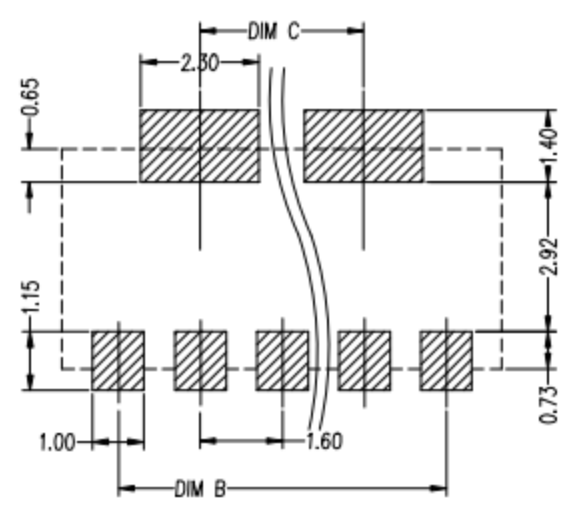
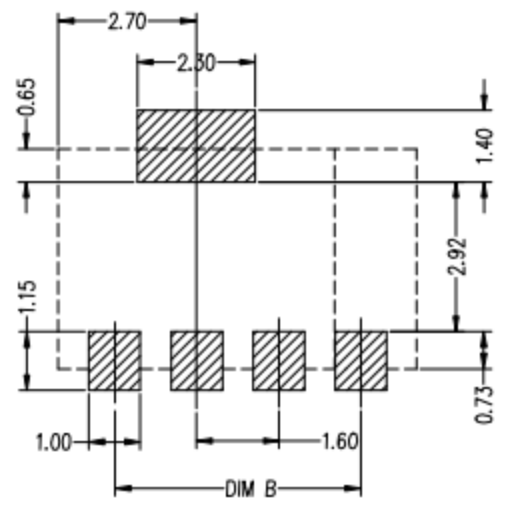
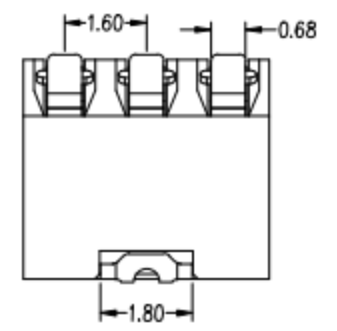
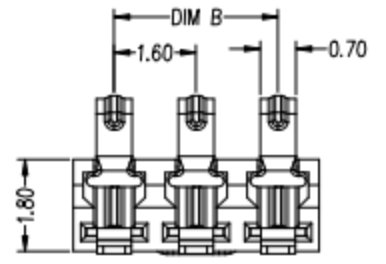

性能:
 额定电流: 3.0A
 额定电压: 24V
 耐电压: 500V
 接触电阻: 30mΩ MAX
 绝缘电阻: 500MΩ
 工作温度: -40℃ ~ +85℃
 塑件(材质): LCP, 耐高温260℃
 接触点(材质): 铜合金, 触点镀金3U'

RECOMMENDED PCB LAYOUT
 TDL:(±0.05)

UNLESS OTHERWISE SPECIFIED TOLERANCES				东莞市高迪电子有限公司			
DECIMALS:		ANGLES:					
DIM	TOL	DIM	TOL	DESIGN:	PART NO.		
X.	±0.50	X.	±2°	CHECK:	REV. UNIT: SHEET:		
X.X	±0.30	X.X	±1°	APPROVED	A	mm 1/1	
X.XX	±0.20	X.XX					
X.XXX	±0.10	X.XXX					

ITEM	PART NAME	Q'TY	MATERTAL	DESCRIPTION	REMARK
②	HOUSING	1	LCP		BLACK
①	CONTACT A	2	PHOSPHOR BRONZE 0.20T	Au PLATED	